

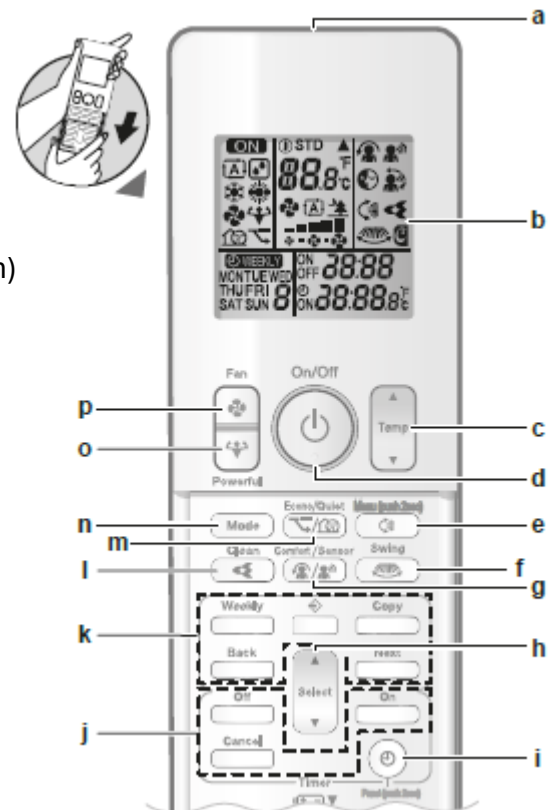















Daikin Airconditioning

- A. Signaalzender
- B. Lcd-scherm
- C. Temperatuurregelknop
- D. AAN/UIT-knop
- E. Knop en menu verticaal draaien (2 seconden drukken)
- F. Knop horizontaal draaien
- G. Knop Comfort airflow en Intelligent eye
- H. Selectieknop
- I. Klokknop en paneel openen (2 seconden drukken)
- J. Knoppen voor in-/uitschakeltimer
- K. Knoppen voor weektimer
- L. Streamer
- M. Knop Econo en geluidsarme stand buitenunit
- N. Standknop
- O. Powerful-knop
- P. Ventilatorknop









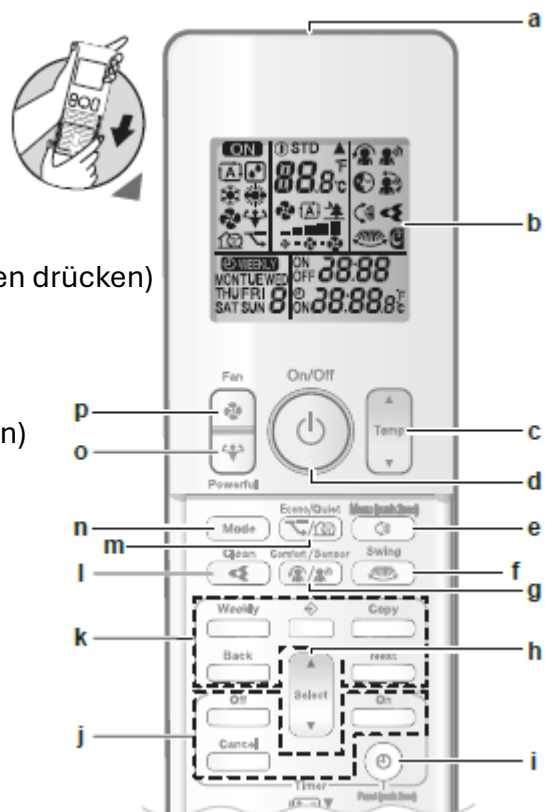









Symbol	Beschrijving	Geluid	Beschrijving
	De unit is in werking	Biep-biep	De werking begint
	Bedrijfsstand = Automatisch	Biep	De instelling verandert
	Bedrijfsstand = Drogen	Lange biep	De werking stopt
	Bedrijfsstand = Verwarmen	Inschakelen/ Uitschakelen	
	Bedrijfsstand = Koelen	Druk een of meerdere keren op de 'MODE' toets om de bedrijfsstand te selecteren	
	Bedrijfsstand = Alleen ventilator	Druk op de  toets en de geselecteerde stand worden op het scherm weergegeven	
	Powerful-functie is actief	Druk één of meerdere keren op de  of  om de temperatuur te verlagen of te verhogen	
	Econo-functie is actief	Druk op de  toets om te stoppen	
	Geluidsarme stand buitenunit is actief		
	Luchtstroomsnelheid = Automatisch		
	Luchtstroomsnelheid = Binnen unit stil		
	Luchtstroomsnelheid		

Daikin Klimaanlage

- A. Signalgeber
- B. LCD-Bildschirm
- C. Temperaturregelknopf
- D. EIN/AUS-Taste
- E. Taste für vertikale Ausrichtung & Menü (2 Sekunden drücken)
- F. Taste für horizontale Ausrichtung
- G. Taste für Komfortluftstrom und Intelligent Eye
- H. Auswahltaste
- I. Uhrtaste & Bedienfeld öffnen (2 Sekunden drücken)
- J. Tasten für Ein-/Ausschalt-Timer
- K. Tasten für Wochentimer
- L. Streamer
- M. Econo-Taste & Leiser-Modus Außengerät
- N. Modus-Taste
- O. Powerful-Taste
- P. Ventilator-taste









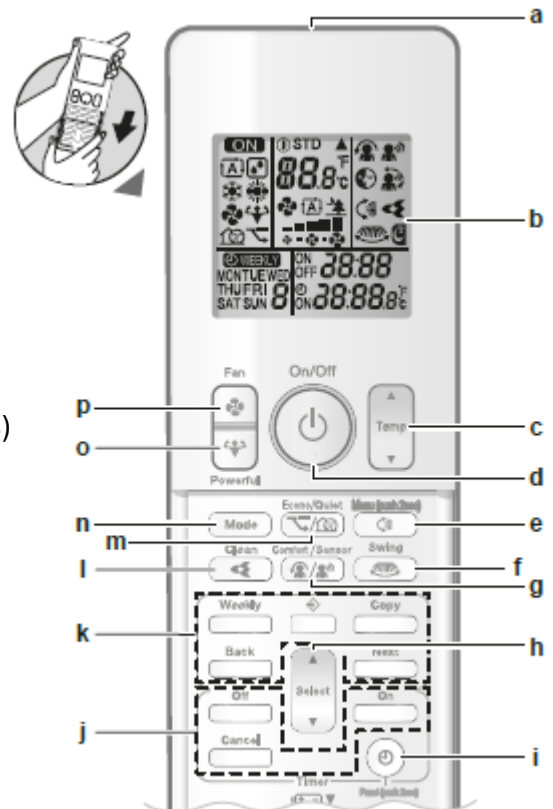









Symbol	Beschreibung	Geräusch	Beschreibung
	Das Gerät ist in Betrieb	Piep-piep	Der Betrieb beginnt
	Betriebsmodus = Automatisch	Piep	Die Einstellung wird geändert
	Betriebsmodus = Entfeuchten	Langer piep	Der Betrieb endet
	Betriebsmodus = Heizen	Ein- / Ausschalten	
	Betriebsmodus = Kühlen	Drücken Sie ein- oder mehrmals die Taste „MODE“, um den Betriebsmodus auszuwählen.	
	Betriebsmodus = Nur Ventilator	Drücken Sie die Taste  und der ausgewählte Modus wird auf dem Display angezeigt.	
	Powerful-Funktion ist aktiv	Drücken Sie ein- oder mehrmals die Tasten  oder  um die Temperatur zu senken oder zu erhöhen.	
	Econo-Funktion ist aktiv	Drücken Sie die Taste  um den Betrieb zu stoppen	
	Leiser Modus der Außeneinheit ist aktiv		
	Luftstromgeschwindigkeit = Automatisch		
	Luftstromgeschwindigkeit = Innengerät leise		
	Luftstromgeschwindigkeit		

Daikin Air Conditioning

- A. Signal transmitter
- B. LCD screen
- C. Temperature control button
- D. ON/OFF button
- E. Vertical swing/menu button (press for 2 seconds)
- F. Horizontal swing button
- G. Comfort airflow and Intelligent Eye button
- H. Selection button
- I. Clock button and panel open (press for 2 seconds)
- J. Timer ON/OFF buttons
- K. Weekly timer buttons
- L. Streamer
- M. Econo and Outdoor Unit Silent Mode button
- N. Mode button
- O. Powerful button
- P. Fan button



Symbol	Description	Noise	Description
	The unit is operating	Beep-beep	The operation starts
	Operation mode = Automatic	Beep	The setting changes
	Operation mode = Dry	Long beep	The operation stops
	Operation mode = Heating	Turn On / Turn Off	
	Operation mode = Cooling	Press the 'MODE' button one or more times to select the operation mode.	
	Operation mode = Fan only	Press the button  and the selected mode will be displayed on the screen.	
	Powerful-functie is actief	Press the button  or  one or more times to decrease or increase the temperature.	
	Econo function is active	Press the  button to stop.	
	Outdoor unit quiet mode is active		
	Airflow speed = Automatic		
	Airflow speed = Indoor unit silent		
	Airflow speed		